

PARTS BREAKDOWN

ITEM	MODEL
49083	DI-IT-0030-MT3

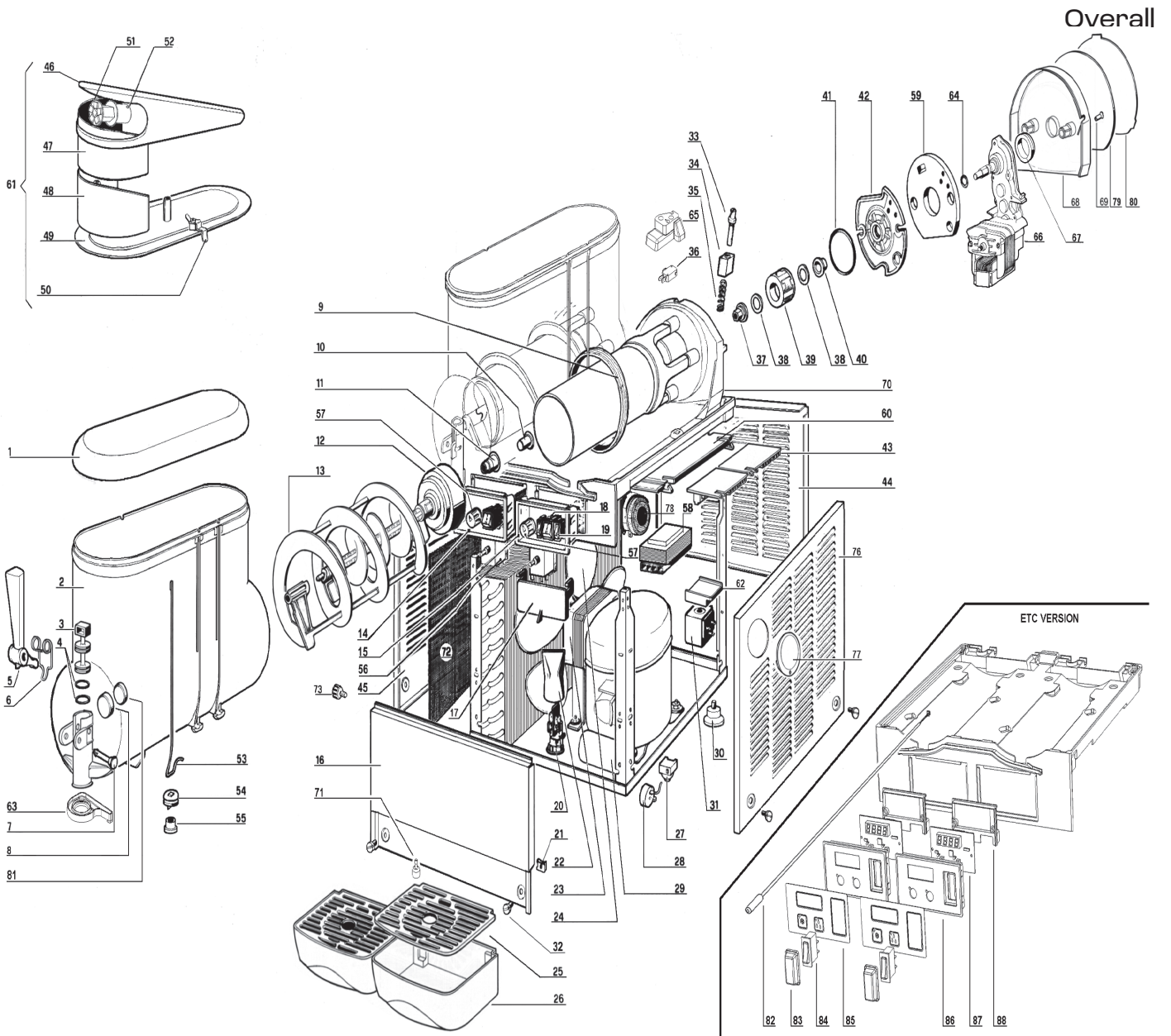

PARTS BREAKDOWN

ITEM	MODEL
49083	DI-IT-0030-MT3

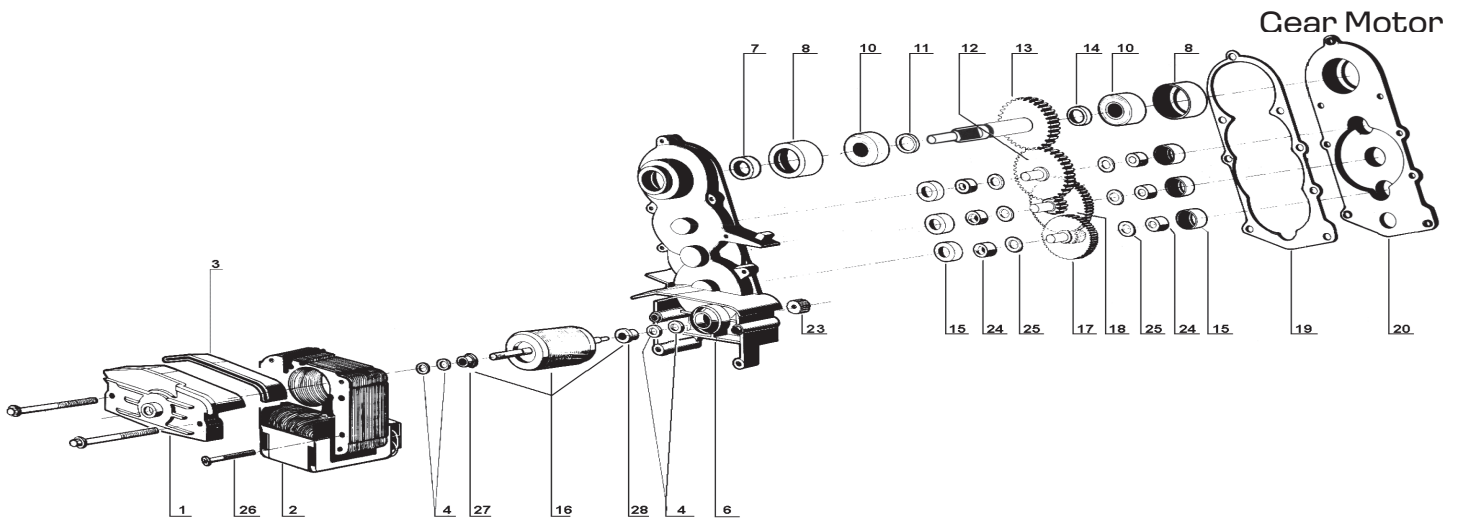

PARTS BREAKDOWN

ITEM	MODEL
49083	DI-IT-0030-MT3

Overall

Item No.	Description	Position	Item No.	Description	Position	Item No.	Description	Position
AS471	Transparent Cover for 49083	1	AS510	Drip Tray for 49083	26	AS416	Fixing Ring for 49083	55
AS472	Bowl for 49083	2	AS392	Rubber Leg for 49083	30	AS417	Thermostat for 49083	56
AS369	Faucet Piston for 49083	3	AS394	Stainless Steel Fixing Screw for Panel for 49083	32	AS418	Thermostat Knob for 49083	57
AS370	Faucet Piston OR for 49083	4	AS395	Density Adjustment Screw for 49083	33	AS512	Transformer for 49083	58
AS473	Faucet Handle for 49083	5	AS396	Shaped Nut for 49083	34	AS420	Insulation Foam for 49083	59
AS368	Faucet Handle Spring for 49083	6	AS397	Spring for 49083	35	AS491	PWB Housing for 49083	60
AS371	Faucet Handle Pin for 49083	7	AS398	Microswitch for 49083	36	AS492	Lighted Top Cover (Assy.) MT for 49083	61
AS372	Thrust Washer Rubber Cap for 49083	8	AS399	Rear Wall Rear Bushing for 49083	37	AS413	Solenoid Valve Plastic Cap for 49083	62
AS474	Bowl Gasket for 49083	9	AS400	Magnetic Drive Washer for 49083	38	AS423	Condensate Collection Seal for 49083	63
AS375	Rear Wall Front Bushing for 49083	10	AS401	Magnetic Drive for 49083	39	AS424	Central Shaft OR for 49083	64
AS376	Auger Bushing for 49083	11	AS402	Flange Bushing for 49083	40	AS493	Micro-Switch Protection for 49083	65
AS377	Auger for 49083	12	AS403	Flange OR 3231 for 49083	41	AS494	Gear Motor for 49083	66
AS475	Outer Spiral for 49083	13	AS404	Gear Motor Flange for 49083	42	AS426	Rear Bushing for 49083	67
AS379	Switch Box for 49083	14	AS481	MT Delay Electronic Device for 49083	43	AS495	Rear Cover for 49083	68
AS380	Power Switch Box for 49083	15	AS514	Back Panel for 49083	44	AS496	Black Rear Cover Fixing Screw for 49083	69
AS513	Dispensing Side Panel for 49083	16	AS483	Side Panel for 49083	45	AS497	Complete Evaporator (White Version) for 49083	70
AS382	Switch Panel Cover for 49083	17	AS484	Lighted Top Cover (Upper) for 49083	46	AS393	Float Level for 49083	71
AS383	3-Position Switch for 49083	18	AS485	Picture for 49083	47	AS498	Condenser Filter for 49083	72
AS384	Switch for 49083	19, 84	AS486	Picture Screen for 49083	48	AS431	MT Side Panel Fixing Grey Knob for 49083	73
AS385	Terminal Block with Cable Clamp for 49083	20	AS487	Lighted Top Cover (Lower) for 49083	49	AS499	Right Side Panel for 49083	76
AS386	Clip for 49083	21	AS488	Top Cover Light Contact for 49083	50	AS432	Timer Cover for 49083	77
AS387	Terminal Block Protection for 49083	22	AS434	Bulb for 49083	51	AS422	Timer Switch for 49083	78
AS477	Fan Motor for 49083	23	AS435	Bulb Socket for 49083	52	AS500	Rear Cover Picture for 49083	79
AS478	Fan Blade for 49083	24	AS489	Light Wire for 49083	53	AS501	Rear Cover Picture Screen for 49083	80
AS509	Drip Tray Cover for 49083	25	AS415	Flexible Contact for 49083	54	AS373	Thrust Washer for 49083	81

PARTS BREAKDOWN

ITEM	MODEL
49083	DI-IT-0030-MT3

Overall

Item No.	Description	Position	Item No.	Description	Position	Item No.	Description	Position
AS502	Temperature Probe for 49083	82	AS504	Adhesive for Keyboard with Main Switch for 49083	85	AS506	Display Card for 49083	87
AS503	Switch Cap for 49083	83	AS505	Display Card Support for 49083	86	AS507	Display Card Holder Cover for 49083	88

Gear Motor

Item No.	Description	Position	Item No.	Description	Position	Item No.	Description	Position
AS515	Bracket with Bush for 49083	1	AS455	1.5mm Spacer for 49083	11	AS520	Gasket for 49083	19
AS516	Stator for 49083	2	AS456	Third Gear for 49083	12	AS521	Gear Box Cover for 49083	20
AS449	Stator Protection Gasket for 49083	3	AS518	Fourth Gear for 49083	13	AS465	Pinion for 49083	23
AS450	Washer for 49083	4	AS458	3.3mm Spacer for 49083	14	AS466	Bushing for 49083	24
AS517	Gear Box with Bushing for 49083	6	AS519	Bushing Rubber Cap for 49083	15	AS467	Washer for 49083	25
AS452	Seal Retainer for 49083	7	AS460	Rotor with Spacer for 49083	16	AS468	Bracket Screw for 49083	26
AS453	Ball Bearing Rubber Cap for 49083	8	AS461	First Gear for 49083	17	AS469	Spacer (Stator Side) for 49083	27
AS454	Ball Bearing 28mm for 49083	10	AS462	Second Gear for 49083	18	AS470	Spacer (Box Side) for 49083	28